

# Circle Problems

ANSWERS

Give answers to 2 decimal places

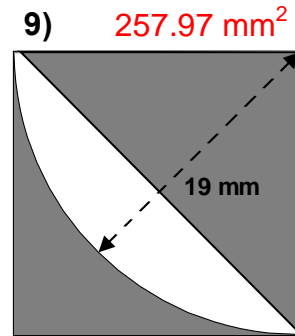
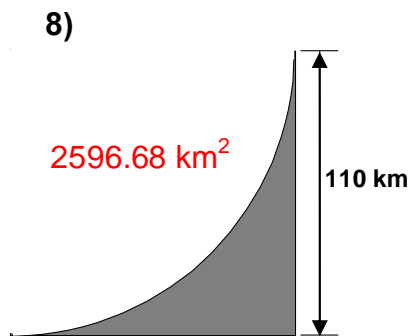
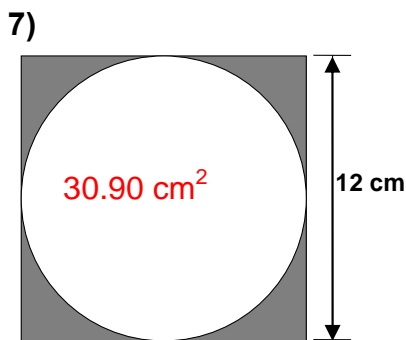
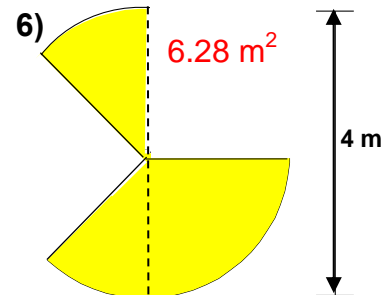
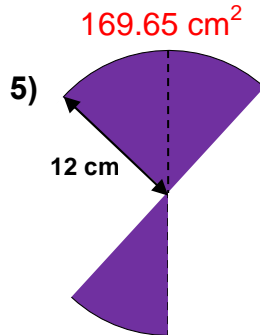
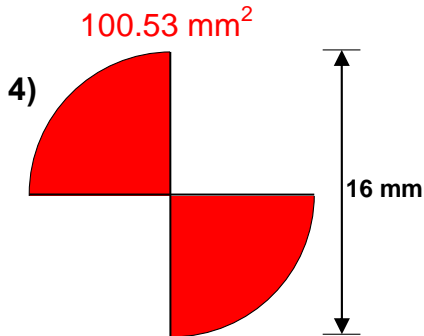
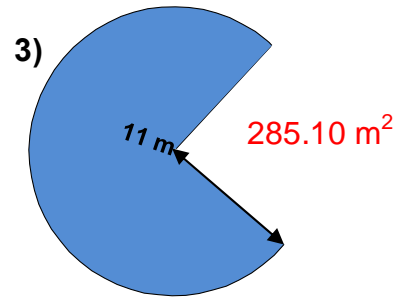
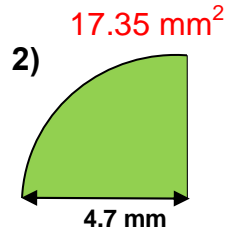
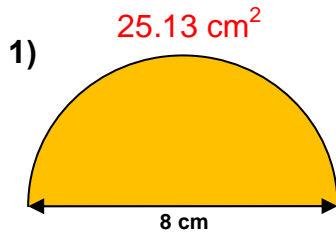

$1351274.82 \text{ m}^2$

$10000 \text{ mm}^2$

$391.07 \text{ cm}^2$

